

# WOLF'S PLUMB BOB NEWS 2014

Issue 09 September 1, 2014

## 5<sup>th</sup> COLLECTORS MEETING in PISA part 2

Author: Wolf Ruecker

[www.plumbbobcollectors.info](http://www.plumbbobcollectors.info)

Dear Fellow Collector,

Dear reader of the PLUMB BOB NEWS,

As always, I am searching for new material and information associated with plumb bobs.

Please feel free to share new photos, catalogs, articles or stories of a personal nature.

I welcome input from fellow collectors!

Wolf

## 5<sup>th</sup> COLLECTORS MEETING in PISA part 2

### TABLE OF CONTENT

1. INTRODUCTION .....	103
2. SIGHTSEEING IN PISA AND LUCCA .....	103
3. THE FESTIVAL OF LIGHTS „LUMINARA“ .....	107
4. PRESENTATIONS of collectors .....	109
5. SOMETHING TO SMILE (or think) ABOUT .....	117
6. REMARK.....	117

### 1. INTRODUCTION

In the last newsletter I wrote about the excellent plumb bob exhibition of Riccardo Chetoni and the presentation of the Groma by the Legio X from Rome. Part 2 will show you that we also have had a nice time with sightseeing and some presentations about plumb bobs.

### 2. SIGHTSEEING IN PISA AND LUCCA

Below you find some impressions from our visit in Pisa. I will not make a tourist-information-guide from these pictures. If you are interested to know all the details about the buildings in Pisa, please visit the [www](http://www).



Riccardo placed in several windows of shops the information about our meeting and put some plumb bobs in. A lot of work!





Riccardo is testing his umbrella.  
 The weather was not every time as planned. Only Dick was happy: *"It is raining like at home in WALES, UK"* ☺

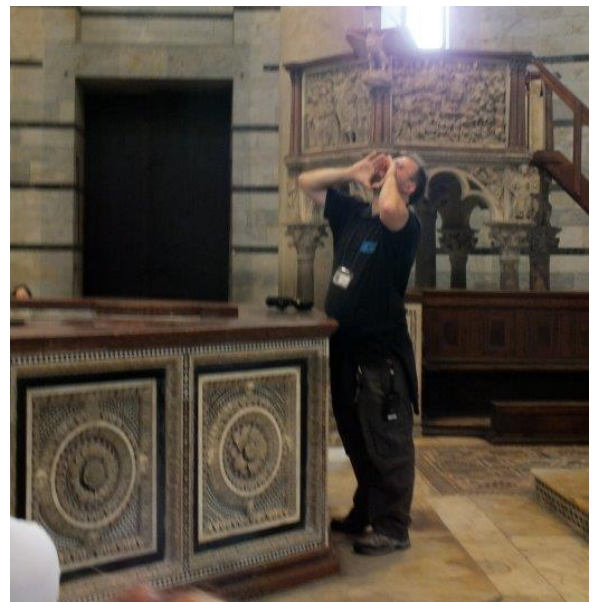

Test of the acoustics

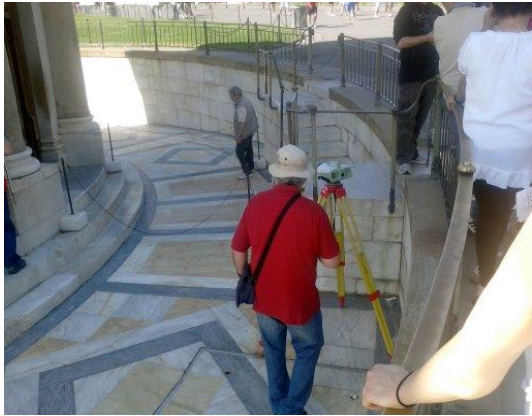
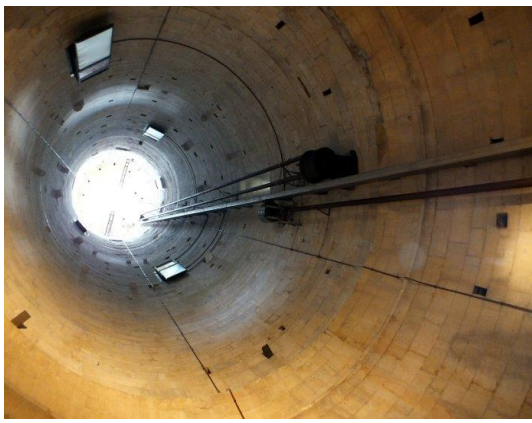
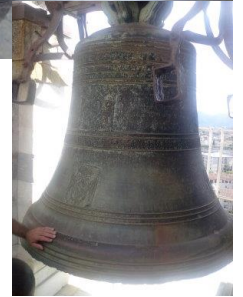

Fig. above: The installation inside the bell tower to verify the data of the LEANING bell TOWER  
 Fig. left: Surveyors at work in front of the tower



Sorry, from our visit in the nice old town of LUCCA nearby Pisa, where we visited on Sunday a big antique market, I found unfortunately only a few photos.



Here are some details of the architecture of Pisa shot by Ulrich Biber:

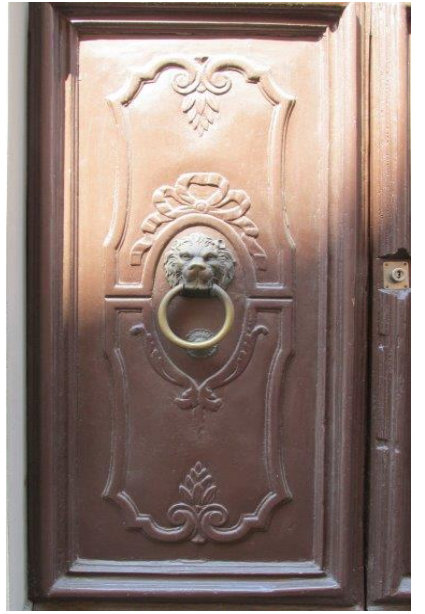

### 3. THE FESTIVAL OF LIGHTS „LUMINARA“

Monday evening (it was the holiday of Saint Ranieri) the community of Pisa celebrated a great firework. All the houses along the river Arno were illuminated by real candles (not electric lamps) and at 11.30 pm they started the firework.

We have had the best places in the whole town: A friend of Riccardo invited us to visit the firework from the terrace on top of a house directly at the river Arno. In such a moment I am happy that our group of collectors is not so big. It was excellent, as the pictures below will show you. I hope you accept that I don't publish any private photos from the party. This is not "facebook". ☺ Thanks to all who sent me the pictures.



Our „VIP-chairs“ at the top of the house



Preparing the candles



Houses at the river Arno. At DAY ...



... and NIGHT



Installing the candles



Skyline of Pisa before the firework



Illumination. View from the 7th floor



Boats as a launching base for the firework



Firework 1



Firework 2



Firework 3



The overcrowded city and the bell tower



Arrivederci Pisa

#### 4. PRESENTATIONS of collectors

I will not replay here the complete presentations of our friends, but give you a very short overview with some photos that show the essentials.

If there are any questions, feel free to ask me or the presenter.

The translator from/to Italian was Chris Powell (Fig. right)



P 02 FR ALLEGORY ON EQUALITY by Dogan Basak, Istanbul, Turkey.

**The A-level as a symbol for equality in the French Revolution.**



Dogan is the specialist for “the plumb bob as a symbol” in our group. The A-LEVEL was the symbol for EQUALITY in the French Revolution 1789 – 1799. We know the A-level as a levelling instrument (TOOL) used by masons, carpenters and surveyors, but in the politic it was used as a SYMBOL. Below a selection of his pictures.



Female figure, draped, standing and holding a triangle above her head. 1794-British Museum.

[plumbbobwolf@t-online.de](mailto:plumbbobwolf@t-online.de)



“La Liberté ou la Mort” 1794  
Jean-Baptiste Regnault (1754-1829)



At the center of is image is “the sacred flame”, who puts on a same level the “white man” and “colored man.” The latter holds in his hand the declaration of the rights of man as well as the decree of the 15<sup>th</sup> May 1791 that recognized the equality of rights to non-whites in the French colonies... as long as they were born of free parents.

From his collection of COINS AND STAMPS:



P 03 MUNITIONS AS PLUMB BOBS by Ulrich Biber, Breklum, Germany

A modern cartridge consists of the following parts:

1. the *bullet*, as the projectile;
2. the *case*, which holds all parts together;
3. the *propellant*, for example **gunpowder** or cordite;
4. the *rim*, which provides the extractor on the firearm a place to grip the casing to remove it from the chamber once fired;
5. the *primer*, which ignites the propellant.

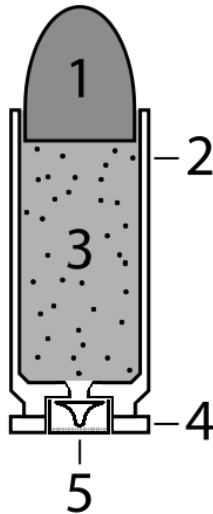

A plumb bob is the best use of munition!

*Plumb Bob WWI: Duke of Cornwall Light Infantry Regiment (DCLI), France 1914-1918. Made from a large Spent Cartridge*



Words from the bible:

*And he shall judge among many people, and rebuke strong nations afar off; and they shall beat their swords into plowshares, and their spears into pruning hooks. Nation shall not lift up a sword against nation, neither shall they learn war any more.*

Micah 4:3



Patent US 4,208,946 Jun. 24, 1980  
FIREARM ALIGNMENT AND SUPPORT APPARATUS.

ABSTRACT: The apparatus is designed for use with a conventional surveyor's tripod, and is primarily for use in the surveying method known as vertical projection surveying.

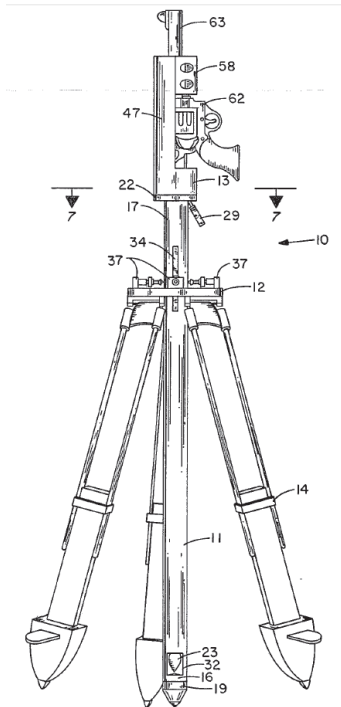

THE USE OF MUNITION AS PLUMB BOBS MAY BE DANGEROUS, if there are still explosives in it.



P 04 THE KANT MEDAL 1784 with Leaning Tower of Pisa and plumb bob by Wolf Ruecker, Langenlonsheim, Germany. (Complete presentation you can read in my newsletter 2014-07)

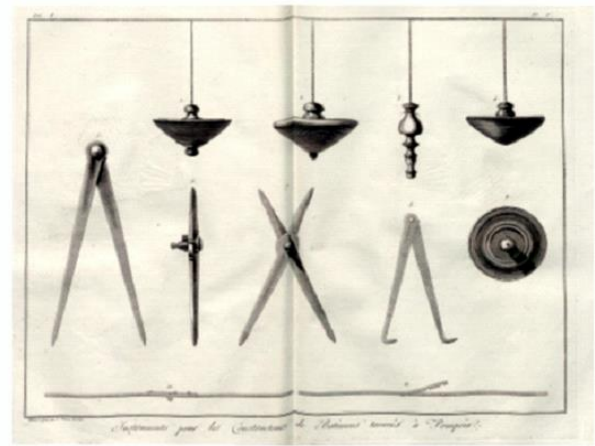

## Il Museo Nazionale Archeologico di Napoli

La sala «Strumenti e tecnologia meccanica»



P 05 THE PLUMB BOBS IN ITALIAN MUSEUMS by Dott. Giovanni di Pasquale, Florence, Italy

He showed us what ancient tools (not only plumb bobs) are stored in Italian museums.

One statement I remember: *“We have not enough manpower to check and present to the public all the tools that we have in our stores.”*

Two pages from Italian books:

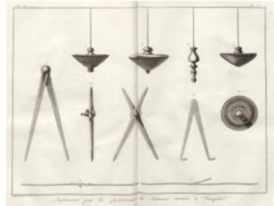

«Il Real Museo Borbonico», Roma 1836, vol. IV, tav. 23

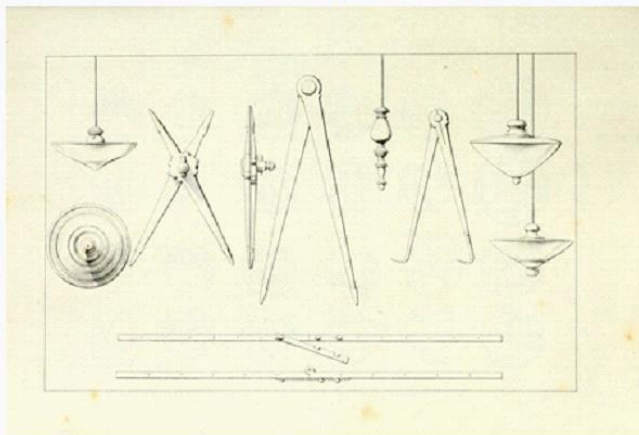

Lastra con strumenti da lavoro dall'abitazione di Diogenes structor, Pompei (VII, 15, 2)



P 06 SOME THOUGHTS ON THE USE OF THE ANATOLIAN PLUMB BOB by Elias Zacharopoulos, Athens, Greece

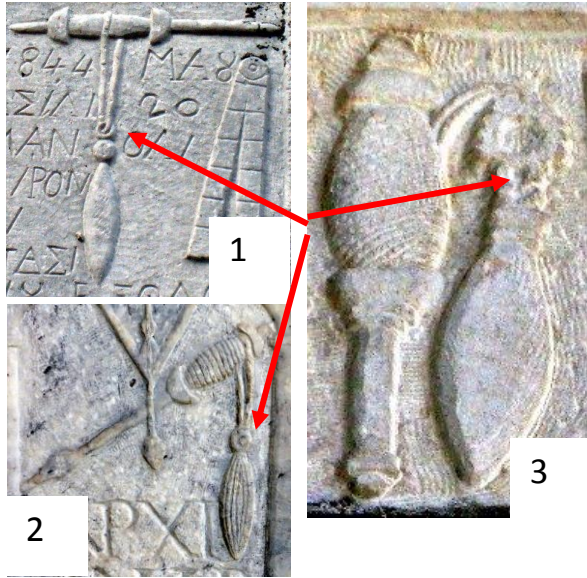

Elias ended his Athens 2012 presentation (On the last meeting) of “stone reliefs” questioning the fact that on some reliefs Anatolian plumb bobs are depicted as hung by a **line passing through the eyelet rather than tied as “usual” to a single line.** (1, 2, 3)

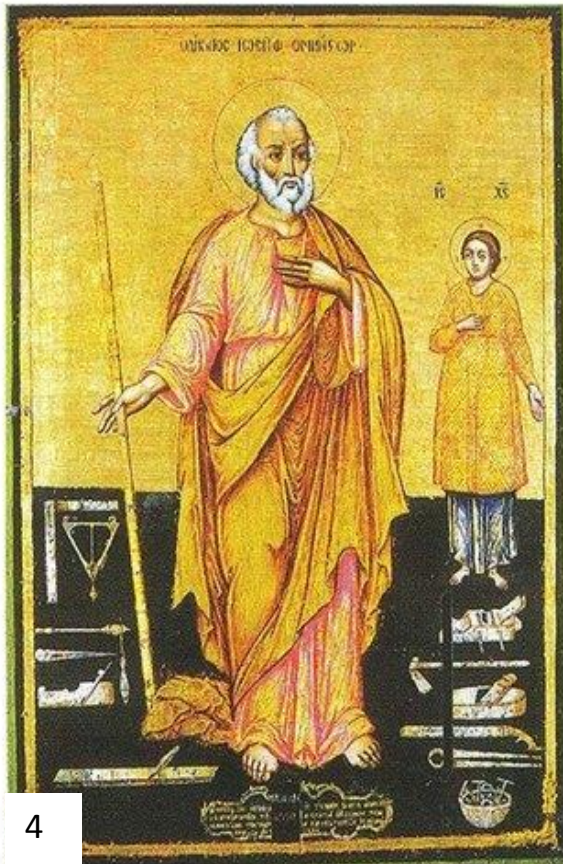

Icon of Saint Joseph with Jesus, ca. 1850, Varna Archaeological Museum, Varna, Bulgaria

A clue to this “mystery” was given in the presentation of Ulrich Biber, which included an icon of St. Joseph from the archaeological museum of Varna. (4) At the lower part of the icon there are **detailed drawings of builder’s tools**, among which an Anatolian plumb bob is clearly depicted hung **by a double line.** (5) In fact, the line is seen passing through the eyelet of the plumb bob and is returning back to the reel.



Elias tested this set-up using a wooden reel,



similar to the one of the drawing, a length of double line and an Anatolian plumb bob. (6, 7) He noticed that the advantage of the double line is that **it keeps the plumb bob still**, in contrast to the single line which lets the plumb bob **spin** without control.



7

This can be related to the fact that the seemingly older type of Anatolian plumb bobs had a **polygonal body which the builders had to orient toward the surface they tested.**

Elias went a step further, suggesting that the role of the crown (8) is to mark clearly the orientation of the plumb bob sides.



8

In polygonal plumb bobs, the crown is either parallel to two opposite sides, or points to two opposite edges of the octagonal body. (9)



9

Gradually, possibly due to the western influence, the **polygonal bodied** Anatolian plumb bobs were replaced by **circular (round) bodied** and the rather cumbersome two line hanging method had to be abandoned for the simpler single line method.

The transition is testified by the different shapes of the non-polygonal Anatolian plumb bobs. (10)



10

P 08 PHOTOS FROM THE EXCELLENT COLLECTION OF ALAIN GRANDEAU, Paris, France.

Alain presented photos of his collection (plumb bobs, spools, lines) with the following message: **I like the plumb bobs that show the use and wear.**

Alain, thank you very much for the good photos. These pictures need no text or description. They are speaking for themselves

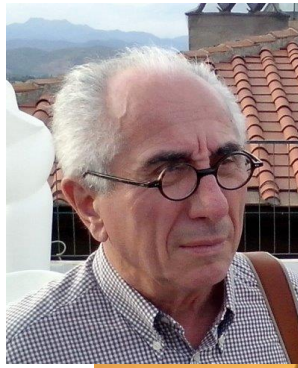





**5. SOMETHING TO SMILE (or think) ABOUT**

There are a lot of collectors, who are searching for excellent and huge plumb bobs like LMSD from UK or patented, polished and marked plumb bobs shown below. I agree that they are looking great and are eye-catchers for a collection and showroom.



But...

... for me also VERY INTERESTING are the plumb bobs that show the REAL LIVE at that time on the building plot: Home-made, used and repaired. Like this one below that I bought recently in Germany. If it could talk to me, that would be great. Thin brass pipe filled with lead, two different strings, damaged and well used. 3 x 1 in, 23 oz.



It looks ugly...



STERLING SILVER ACORN WITH HALLMARK  
UNITED KINGDOM  
4.25"X1.6"  
3.75 OZ.  
#293 DENNY



... but it is telling me a lot from that hard life of the workers at that time when it was used by a skilled mason. Much more than a plumb bob made in a factory (especially for collectors). ☺

**6. REMARK**

DEAR READER OF THE PLUMB BOB NEWS,  
DEAR FELLOW COLLECTOR,

This is an article of the monthly published WOLF'S PLUMB BOB NEWS that is sent on demand as PDF-file attachment by email. FREE. You can see all former publications on the website [www.plumbbobcollectors.info](http://www.plumbbobcollectors.info) on sub page "download publications". Remarks and contact by email: [plumbbobwolf@t-online.de](mailto:plumbbobwolf@t-online.de)

Enjoy it

Wolf Ruecker

[plumbbobwolf@t-online.de](http://plumbbobwolf@t-online.de)

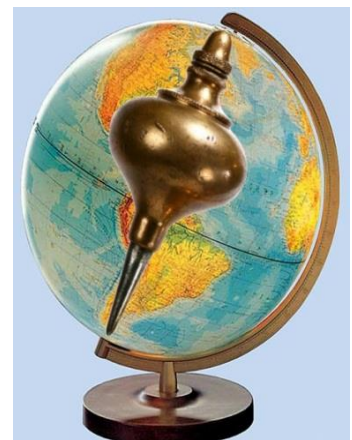

Logo of the IPBCA  
INTERNATIONAL PLUMB BOB  
COLLECTORS ASSOCIATION.  
For us THE WORLD TURNS  
AROUND THE PLUMB BOB