

Wolf's PLUMB BOB NEWS
2010-complete
SUMMARY
of all 12 issues



Information for plumb bob collectors

Editor: Wolf Ruecker

plumbbobwolf@t-online.de

#. **TITLE / CONTENTS**

date: Dec.17, 2010

2010-01

page 8

SOLUTIONS TO ADJUST THE LINE OF A PLUMB BOB (12 pp)

1. INTRODUCTION
2. TIE A SLIDING KNOT
3. PATENTED ADJUSTERS
4. COMMON ADJUSTERS
5. INTEGRATED ADJUSTERS (REELS etc.)
6. OOF THE SUBJECT
7. CONCLUSION



2010-02

page 20

EGYPT PLUMB BOBS + SCALES WITH PLUMMET (11 pp)

1. INTRODUCTION
2. WEIGHING OF THE HEART
3. WHAT TYPES OF „SCALE-PLUMMETS“EXIST?
4. EGYPT PLUMB BOBS AND A-LEVELS
5. CONCLUSION



2010-03

page31

PLUMB BOB LINES (10 pp)

1. INTRODUCTION
2. WHY WE NEED A LINE?
3. WHAT REQUIREMENTS DO WE HAVE for a line?
4. DIFFERENT TYPES AND MATERIAL
5. WHAT INFORMATION DO WE GET FROM BOOKS?
6. HOW ARE LINES PRODUCED?
7. MY QUESTIONNAIRE 2008
8. PIANO WIRE
9. PICTURES FROM FELLOW COLLECTORS
10. CONCLUSION

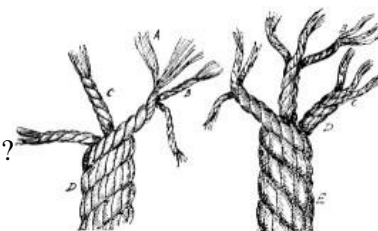

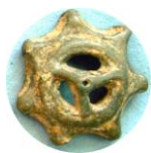

Wolf's PLUMB BOB NEWS

2010-complete
SUMMARY
of all 12 issues



Information for plumb bob collectors

Editor: Wolf Ruecker

plumbbobwolf@t-online.de

#. **TITLE / CONTENTS**

2010-04

page 41

ENGLISH PLUMB BOS PART 1 (18 pp)

1. INTRODUCTION
2. WHAT IS INTERESTING IN ENGLISH PLUMB BOBS?
3. ENGLAND; MAKERS
4. COLLECTION RICHARD JONES, WALES
5. UNMARKED
6. OTHER DISTRIBUTORS
7. PATENTED PLUMB BOBS
8. LAST BUT NOT LEAST
9. RELATED PUBLICATIONS



2010-05

page 59

ENGLISH PLUMB BOS PART 2(18 pp)

1. INTRODUCTION
2. LAIRD SHIPYARD
3. PLUMB BOBS IN AUSTRALIA
4. PATENTED PLUMB BOB FROM AUSTRALIA
5. PLUMB BOBS IN NEW ZEALAND
6. PLUMB BOBS IN CANADA
7. PLUMB BOBS IN INDIA
8. CONCLUSION
9. RELATED PUBLICATIONS



2010-06

page 72

HIGHLIGHTS FROM MY READER'S COLLECTIONS (17 pp)

0. INTRODUCTION
1. YOUR OLDEST PLUMB BOB?
2. YOUR BIGGEST / HEAVIEST PLUMB BOB?
3. YOUR SMALLEST PLUMB BOB?
4. YOUR MOST BEAUTIFUL PLUMB BOB?
5. YOUR MOST UNSIGHTLY PLUMB BOB?
6. YOUR MOST UNUSUAL / EXTRAORDINARY P B?
7. YOUR "DARLING"?
8. YOUR MOST EXPENSIVE PLUMB BOB?
9. YOUR MOST INTERESTING PLUMB BOB?
10. YOUR P B WITH THE BEST STORY OR HISTORY?
11. WHICH PLUMB BOB TRAVELLED THE LONGEST DISTANCE?
12. YOUR MOST WIMSICAL PLUMB BOB?
13. YOUR RAREST PLUMB BOB?
14. YOUR VERY FIRST PLUMB BOB?
15. WHICH PLUMB BOB WOULD YOU MOST LIKE TO ADD TO YOUR COLLECTION?



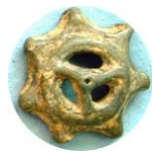

Wolf's PLUMB BOB NEWS
2010-complete
SUMMARY
of all 12 issues



Information for plumb bob collectors

Editor: Wolf Ruecker

plumbbobwolf@t-online.de

#. TITLE / CONTENTS
2010-07

page 89

THE MOUNT RUSHMORE PLUMB BOBS (8 pp)

0. INTRODUCTION
1. MOUNT RUSHMORE + MUSEUM
2. SCULPTOR GUTZON BORGLUM
3. THE POINTING SYSTEM
4. THE PLUMB BOBS
5. REMARK
6. FOOTNOTES AND SOURCES

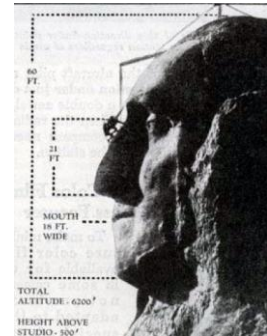

page 97

2010-08

SPECIAL USES OF PLUMB BOS (16 pp)

0. INTRODUCTION
1. CYCLING
2. KITE
3. GOLF
4. BOWLS
5. PINBALL
6. AEROMODELLING
7. BOMBER TRAINING
8. CARS + RAILWAYS
9. AMUSEMENT
10. ARCHERY
11. SOMETHING TO SMILE ABOUT
12. SOURCES AND FOOTNOTES

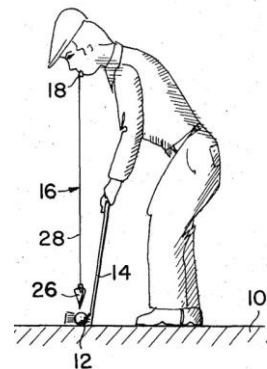

2010-09

page 113

100 YEAR ANNIVERSARY, PLUMB BOB (and CHALK LINE) PATENTS (15 pp)

0. INTRODUCTION
1. FR 406122 SCHOTT (FRANCE) 1909 THE RATIONAL P B
2. US 932218 WILSON 1909 REEL FOR PLUMB BOBS
3. US 927790 HALL 1909 CHALK LINE HOLDER
4. US 995938 AIRESMAN filed 1910 PLUMB BOB
5. US 995872 JOICE filed 1910 PLUMB BOB
6. US 971752 HULL 1910 LEVELLING AND GRADING INSTRUMENT
7. US 944654 BERGER 1909 MINING TRANSIT CENTER FINDER
8. US 916608 SCHMIDTKE 1909 PLUMB BOB
9. US 922171 LOEVEN 1909 PLUMB BOB
10. US 921302 STARR 1909 LINE CHALKER
11. US 953131 FERRIS 1910 SHAFT CENTERING DEVICE
12. US 909846 CAVILEER 1909 PLUMB BOB AND CHALK LINE HOLDER
13. US 947892 EASTMAN 1910 CHALK-LINE HOLDER
14. US 1004443 LAUT 1911 CHALK LINE HOLDER

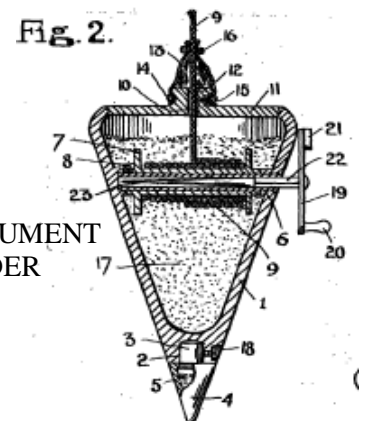



Wolf's PLUMB BOB NEWS

2010-complete
SUMMARY
of all 12 issues

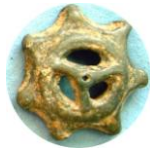

Information for plumb bob collectors

Editor: Wolf Ruecker

plumbbobwolf@t-online.de

#. **TITLE / CONTENTS**

2010-10

page 128

INTERNATIONAL PLUMB BOB COLLECTORS MEETING COLOGNE 2010 (16 pp)

0. INTRODUCTION
1. THE HIGH ROOF OF THE COLOGNE CATHEDRAL
2. PRESENTATIONS
3. TOOL MUSEUM Gerhard Schmitz
4. TUTANKAMUN EGYPTIAN EXHIBITION
5. ROMAN GERMAN MUSEUM
6. NEXT COLLECTORS MEETING 2012
7. REMARKS

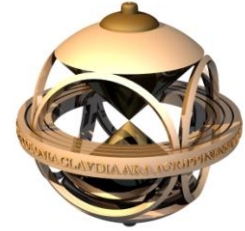

2010-11

page 144

PLUMB BOBS IN DAMS (7 pp)

0. INTRODUCTION
1. WHY A PLUMB BOB IN A DAM?
2. NORMAL PLUMB LINE
3. INVERTED or FLOATING PLUMB LINE
4. HOOVER or BOLDER DAM
5. REMARKS



2010-12

page 151

PLUMB BOB and ADVERTISING (11 pp)

(NOT YET READY)

0. INTRODUCTION
1. PRESENTS
2. LOGOS AND COAT OF ARMS
3. MONUMENTS
4. REMARKS



All these issues are available as single issues and complete for 2010 on
www.plumbbobcollectors.info

Also available on this website are:
the **50 articles from 2007** about PATENTED PLUMB BOBS
and the **articles from 2008 and 2009**.

Enjoy this special information for plumb bob collectors
Wolf Ruecker plumbbobwolf@t-online.de